

MedCenter 5AX

HIGH SPEED **5-AXIS VERTICAL** MACHINING CENTER



MedCenter 5AX The Machine for

Unrivaled Accuracy - Ultra Compact Footprint

Never before has there been a machine that packs so much production, precision and machining flexibility into such a compact footprint. But don't be fooled. The MedCenter-5AX boasts the largest work envelope in its class and weighs in at a massive 4,200 kg (9,260 lbs) for unrivaled high-speed, ultra precise simultaneous 5-axis machining.

Standard High Accuracy Package Includes:

- High resolution optical scale feedback on all axes (includes 4th & 5th)
- 67 million pulse encoder system
- 16mm fine pitch ballscrews
- Arumatik®-Mi High Speed Processing Control

Largest Work Envelope
in its class.

Max Workpiece Size Dia. x H:
220mm (8.7") x 175mm (6.9")

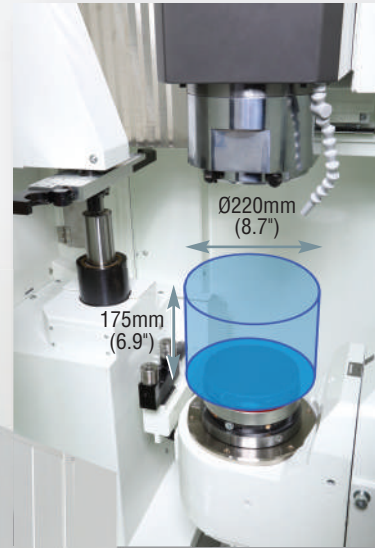

Positioning Accuracy: $\pm 0.002\text{mm}$ ($\pm 0.000079''$) / Full Stroke Repeatability: $\pm 0.001\text{mm}$ ($\pm 0.000039''$)

Complex Parts and Micro Machining

High-Speed Direct Drive 4th & 5th Axis Rotary Table

As simultaneous 5-Axis machining becomes ever-increasingly popular, it's even more critical to keep the competitive edge. That's why we equipped the Medcenter-5AX with highly rigid, high-speed, 4th & 5th axis rotary tables with high resolution optical scale feedback for ultra precise accuracies and smooth movement in complex cutting applications.

	Stroke	Rapids
A-Axis	+/-120 degrees	100min ⁻¹ (36,000deg/min) Integral Motor
C-Axis	360 degrees	200min ⁻¹ (72,000deg/min) Integral Motor

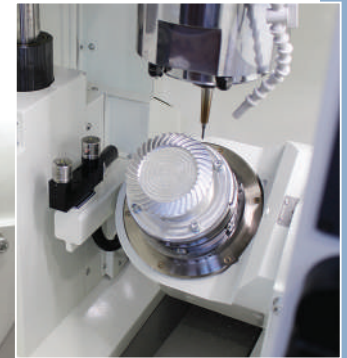
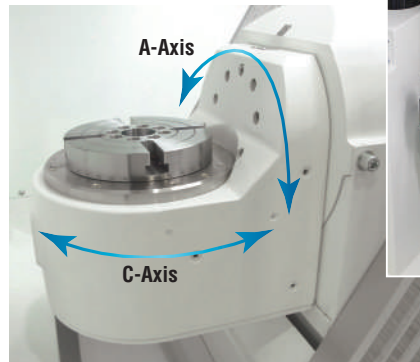

High Speed 30,000min⁻¹ 18kw (24.5HP) Built-in HSK-E40 Spindle

Ideal for highly precise, highly intricate work requiring superb rigidity and ultimate stiffness in spindle construction and function.

- Ideal for small diameter tools
- Hard milling
- Super fine finish capabilities
- Standard air through spindle feature available for dry cutting
- Up to 7MPa (1000psi) coolant through the spindle ready (option) available for deep hole drilling requirements

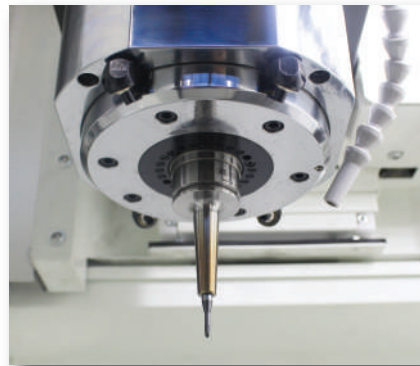

High-Performance ATC Optimizes Cutting Time

The MedCenter-5AX is equipped with Kitamura's patented "Fixed-Pot" ATC renowned for unrivaled tool handling. Old tools are returned to their pot while the next tool is held in the ready position. Tool changes are a lightning fast 1.5 seconds. The tool magazine holds 40 tools and is located at the back of the machine to assure optimum operator access and convenience when setting up tools or performing routine maintenance.



Automation Solutions for Every Application

Eliminate waste, increase productivity and lower costs with flexible automation options.

- Optional 12-station automatic pallet system
- Robot interface option available
- Automatic Door option available
- Anywhere [RemOte](#) email notification and machine condition monitoring software

SPECIFICATIONS *MedCenter5AX*

FLOOR PLAN *MedCenter5AX*

Table	
Size	Ø170mm (Ø6.7")
Maximum Table Load	20kg (44 lbs)
Maximum Workpiece Diameter	Ø220mm (Ø 8.7") with Limitation
Maximum Workpiece Height	175mm (6.9")
Travel	
X-Axis	254mm (10.0")
Y-Axis	330mm (13.0")
Z-Axis	330mm (13.0")
A-Axis	240 Degrees (- 120 to +120 Degrees)
C-Axis	0 to 360 Degrees
Distance from Table Surface to Spindle Center	50 to 380mm (2.0" to 15.0")
Distance from Table Center to Spindle Nose	-155 to 175mm (-6.1" to 6.9")
Spindle	
Spindle Taper	HSK-E40
Spindle Speed	300 to 30,000min ⁻¹
Drive Method	Built-in
Spindle Motor	18kw (24.5 HP) AC/2 Min. 15kw (20 HP) AC/Cont.
Spindle Torque	14.6 N-m (10.8 ft-lbs) / 10 Min.
Feed	
Rapid Feed X, Y-Axes	60m/min (2,362ipm)
Rapid Feed Z-Axis	50m/min (1,969ipm)
Rapid Feed A-Axis	36,000 deg/min (100min ⁻¹)
Rapid Feed C-Axis	72,000 deg/min (200 min ⁻¹)
Cutting Feed	50m/min (1,969ipm)
ATC	
Tool Storage Capacity	40 Tools
Tool Holder Style	HSK-E40
Max. Tool Diameter	Ø50mm (Ø2.0")
Max. Tool Length	200mm (7.9")
Max. Tool Weight	2kg (4.4 lbs)
Tool to Tool	1.5 Seconds
Utilities	
Power Requirement	30KVA, 200V AC, 3 Phase
Air Requirement	0.5MPa, 240L/min (90 psi, 8 cfm)
Machine Dimensions	
Required Space (L x W)	2,045 x 1,200mm (80.5" x 47.2")
Machine Height	2,228mm (87.7")
Machine Net Weight	4,200 Kg (9,260 Lbs)
Control	
	Arumatik-Mi

All specifications subject to change without notice.

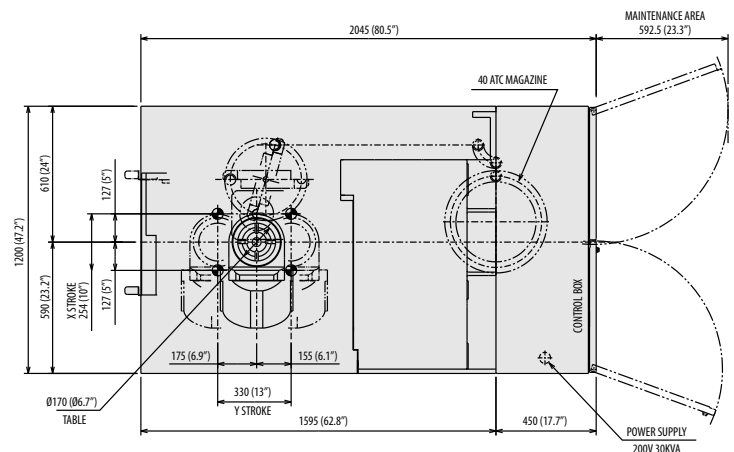
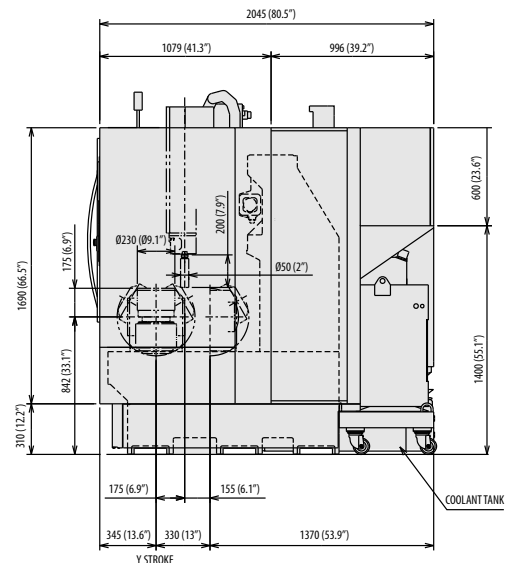
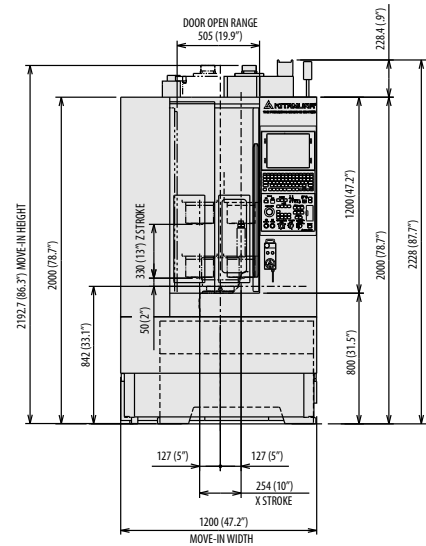

Kitamura Machinery of U.S.A., Inc.
 78 East Century Drive, Wheeling, Illinois 60090
 +1 847 520 7755
 kitamura-machinery.com
 info@kitamura-machinery.com

Kitamura Machinery Co., Ltd.
 1870-Toide, Takaoka-City, Toyama Pref., Japan
 +81 766 63 1100
 kitamura-machinery.co.jp
 mycenter@kitamura-machinery.co.jp

Kitamura Machinery GmbH (Europe)
 Wählerstrasse 39, 40472 Dusseldorf, Germany
 +49 211 65 6077
 kitamura-machinery.eu
 sales@kitamura-machinery.eu